

FERRAGENS E ACESSÓRIOS PARA VIDROS TEMPERADOS



Tel.: (11) 5670 - 9900
Edição 2010



A Empresa



Com o intuito de atender uma necessidade existente no mercado de uma empresa com capacidade de produção rápida e com qualidade, surge em 1997, fundada pelo empresário Paulo Hirata e seus colaboradores, a **GLASSPEÇAS IND. E COM. LTDA.** Desde então, a necessidade de inovação e de superação fazem parte da rotina da empresa.

Buscamos desde o início a administração de acordos comerciais com os melhores fornecedores industriais de matéria prima para podermos oferecer constantemente o mais alto padrão de qualidade exigido pelo mercado, atualmente tão carente desta qualidade.

Estruturada, eficiente e com nível de qualidade amplamente reconhecida no mercado, a história da Glasspeças ainda contou com a contribuição decisiva da política comercial implementada ao longo dos anos. Versáteis e focados nas necessidades determinadas pelos clientes a equipe de vendas e o departamento técnico sempre se empenharam em criar soluções adequadas para atender necessidades específicas de grandes, médios e pequenos pedidos em diversos setores da construção, acabamento e engenharia, incluindo de têmperas até pequenas vidraçarias e pequenos e grandes distribuidores, sempre com o mesmo padrão de atendimento.

A Glasspeças conquistou e manteve clientes em todos os diferentes mercados em que atua por mais de uma década, pois sempre esteve ao lado dos seus clientes, agindo não como fornecedor casual, mas de forma profissional, competente e sendo aliada permanente na busca por soluções para cada necessidade.

desde 1997

Glasspeças.



	Linha Santa Marina	03
	Linha iM	33
	Linha2000	38
	Linha 3000	45
	Linha Premium	58
	Linha Dobradiças Reforçadas	60
	Linha Ferragens Especiais	61
	Linha rdPongadores	68
	Puxador Tubular	70
	Linha Fechaduras de Maçaneta	71
	Acessórios	72
	Aplicações	75



1001
Botão de Correção com Calota
para Vidro
Disponível em Latão e Zamac

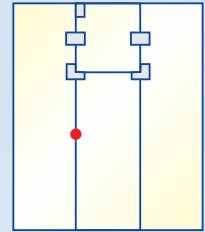

1002
Botão de Correção Simples
(Parafuso)
Disponível em Latão e Zamac

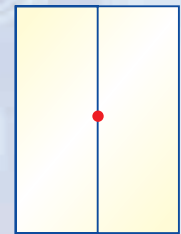

1002 A
Botão de Correção (Lâmina)

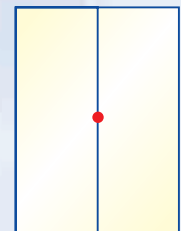

1002 B
Botão de Correção
(Lâmina com Calota)

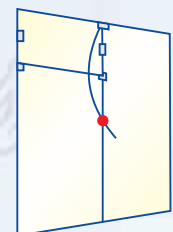

1003
Corrente para Trinco
Basculante por Metro

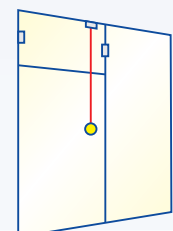



1003 A
Argola para Corrente

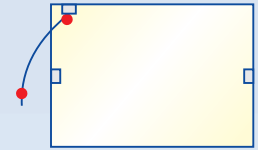

1005
Calota para Corrente
Disponível em Latão e Zamac

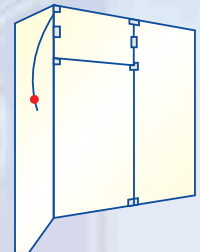

1007
Dobradiça com Freio para
Basculante e Pivotante
Vidro Alvenaria

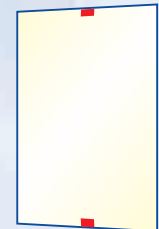

1007 A
Dobradiça com Freio para
Basculante e Pivotante
Vidro Alvenaria

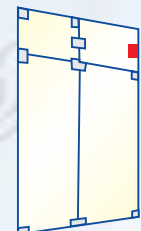

1008
Dobradiça com Freio para
Basculante e Pivotante
Vidro Vidro

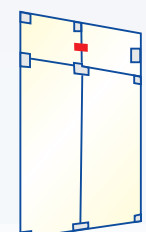



1008 A

Dobradiça com Freio para
Basculante e Pivotante
Vidro Vidro

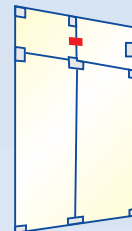

1009

Pivô Inferior para Dobradiça
Disponível em Latão e Zamac

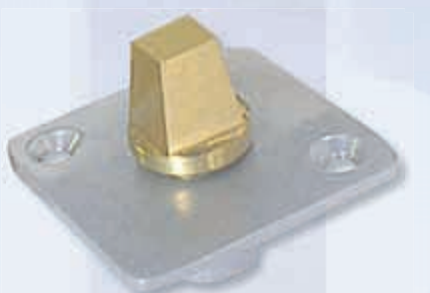

1013

Pivô para Dobradiça Inferior
Disponível em Latão e Zamac



1013 S

Pivô Inferior para Dobradiça
1103 Sul



1014

Pivô para Dobradiça
Excêntrica Inferior
Disponível em Latão e Zamac





1038

Capuchinho para Trinco
com furo de 10mm

Disponível em Latão e Zamac

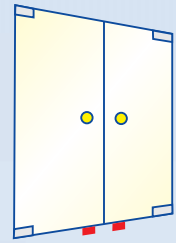

1038 A

Capuchinho para Trinco
(Capelinha)

Disponível em Latão e Zamac

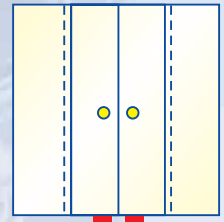

1038 B

Capuchinho para Trinco 1335
Trilho Exposto

Disponível em Latão e Zamac

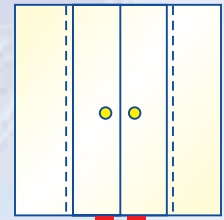

1038 C

Capuchinho para Trinco 1335
Meia lua

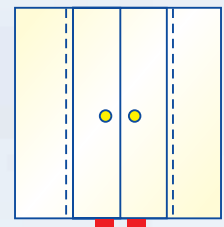

1101

Dobradiça Superior

Disponível em Latão e Zamac

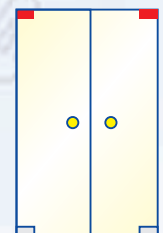

1101S

Dobradiça para Pivô Invertido
Sul

Disponível em Latão e Zamac

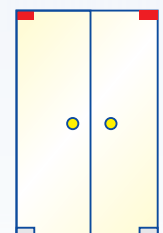



1103

Dobradiça Inferior

Disponível em Latão e Zamac

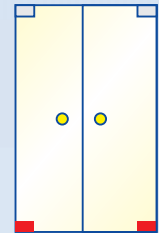

1103S

Dobradiça Inferior para Pivot Sul

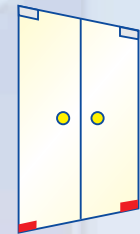

1104

Dobradiça Superior Excêntrica Direita

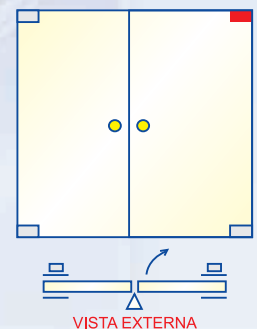

1105

Dobradiça Superior Excêntrica Esquerda

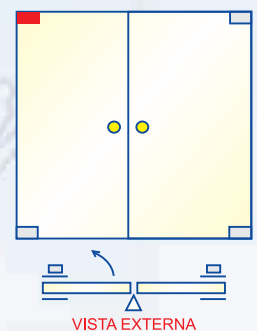

1108

Dobradiça Inferior Excêntrica Direita

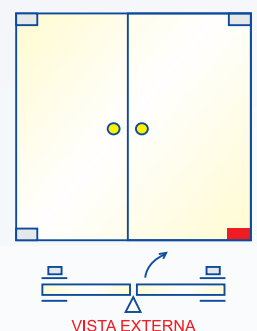



1109
Dobradiça Inferior Excêntrica
Esquerda

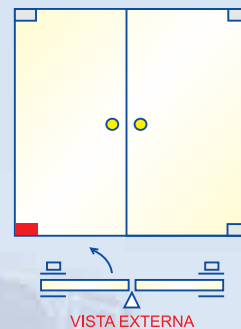

1110
Dobradiça Pivotante Superior



1112
Dobradiça Pivotante Inferior



1112F
Dobradiça Pivotante Inferior
para Mola

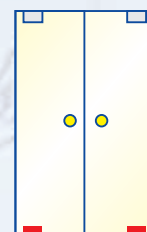

1113
Dobradiça Pivotante Inferior
com Trinco





1114
Dobradiça Automática
para Box

Disponível em Latão e Zamac



1115
Dobradiça sem Caimento
para Box

Disponível em Latão e Zamac



1116
Dobradiça Lateral Horizontal
Simples



1117
Dobradiça Horizontal Dupla

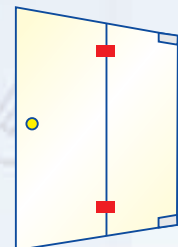

1118
Dobradiça de Batente V/A





1118 D
Dobradiça Batente V/V

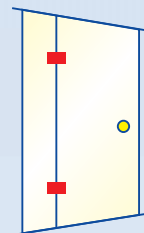

1123
Dobradiça para Vidro
Basculante
Disponível em Latão e Zamac

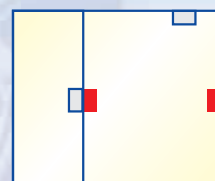

1123 A
Dobradiça para Vidro
Basculante com Trinco



1124
Suporte Superior com Rodízio
para Porta Sanfonada

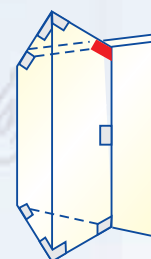

1125
Roldana Simples para Box e
Janela de Correr

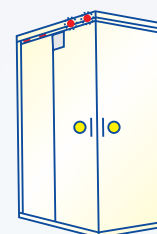



1125 D

Roldana Dupla para Janela de Correr

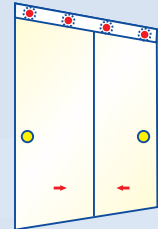

1126 M

Mini Carrinho para Porta de Correr com Rolamento

Disponível em Latão e Zamac

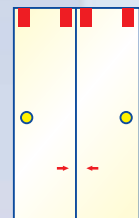

1126

Carrinho para Porta de Correr com Rolamento

Disponível em Latão e Zamac

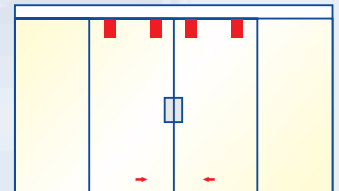

1126 D

Carrinho Duplo para Porta de Correr com Rolamento

Disponível em Latão e Zamac

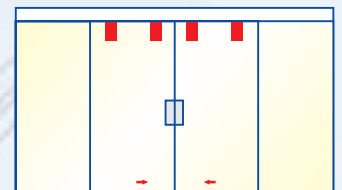

1126 B

Carrinho com Rolamento para Box Padrão

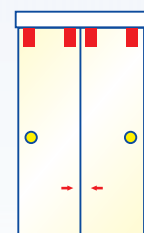

VISTA EXTERNA



1126 MC

Mini Carrinho para Porta de Correr com Rolamento Côncavo

Disponível em Latão e Zamac

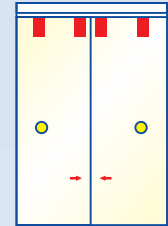

1126 C

Carrinho para Porta de Correr com Rolamento Côncavo

Disponível em Latão e Zamac

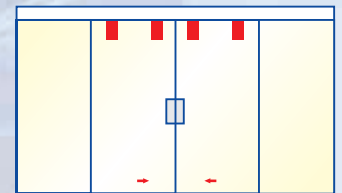

1126 DC

Carrinho Duplo para Porta de Correr com Rolamento Côncavo

Disponível em Latão e Zamac

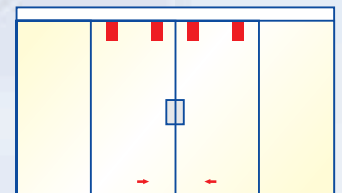

1127

Suporte Central para Porta Sanfonada com Rodízio Duplo

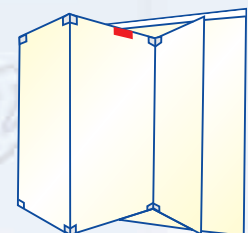

1127 A

Suporte Central Inferior com Pino para Porta Sanfonada

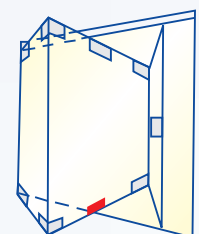



1128 A
Dobradiça Lateral Horizontal
com Ponto de Giro a 65mm

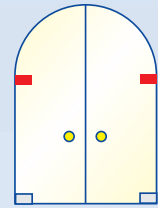

1128 B
Dobradiça Horizontal de Canto
com Ponto de Giro a 65mm

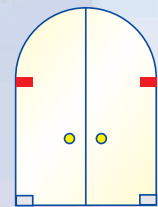

1128 C
Dobradiça Horizontal V/V
com Ponto de Giro a 65mm

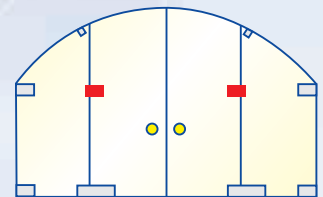

1129 D
Dobradiça Dupla Automática
V/V Direita

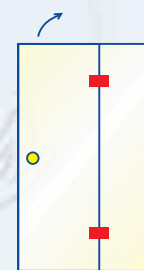

VISTA EXTERNA



1129 E
Dobradiça Dupla Automática
V/V Esquerda

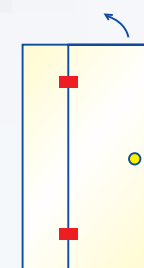

VISTA EXTERNA



1130

Suporte para Basculante e Pivotante com Pino

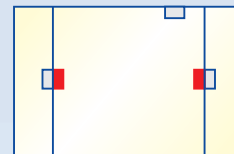

1131

Dobradiça para Porta em Arco com Ponto de Giro Deslocado a 25mm

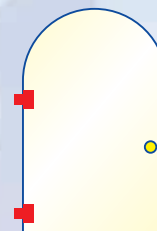

1132

Dobradiça Horizontal Dupla Superior e Inferior

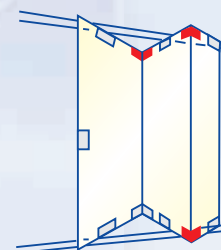

1132 A

Dobradiça Horizontal Dupla com Trinco

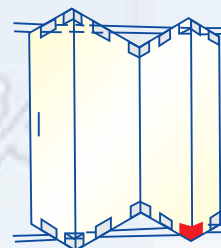

1132 B

Dobradiça Horizontal Dupla com Trinco

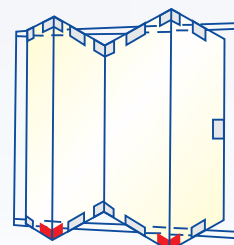



1132 C

Dobradiça Horizontal Dupla
com Trinco

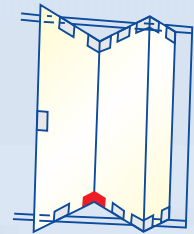

1132 D

Dobradiça Horizontal Dupla
com Trinco

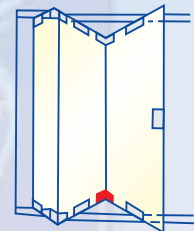

1136

Dobradiça Lateral Horizontal
Giro Deslocado a 25mm

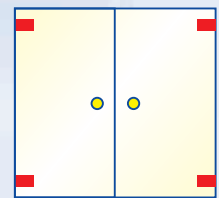

1136 B

Dobradiça Lateral de Batente
sem Eixo de Giro

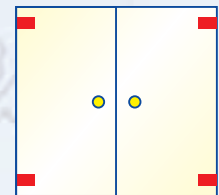

1137

Dobradiça Horizontal Dupla
Giro Deslocado a 25mm

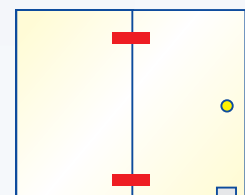



1137 B

Dobradiça Horizontal
Dupla V/V
sem Eixo de Giro

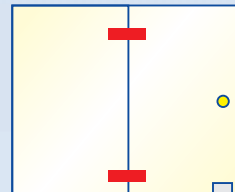

1201

Bucha para Pivot de Dobradiça
Disponível em Latão e Zamac

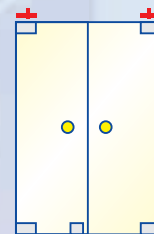

1201 S

Pivot para Dobradiça
1101 S, 1230 e 1231
Disponível em Latão e Zamac

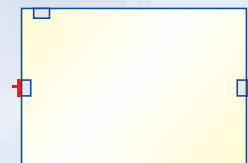

1203

Suporte para Bandeira com
Ponto de Giro para Dobradiça
Superior
Disponível em Latão e Zamac

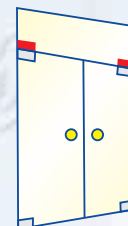

1206

Suporte para Bandeira com
Ponto de Giro Excêntrico
Direito

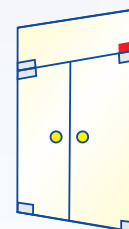

VISTA EXTERNA



1207

Suporte para Bandeira com Ponto de Giro Excêntrico Esquerdo

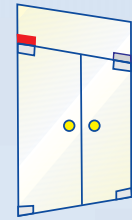

VISTA EXTERNA



1209

Facão Simples para Lateral e Bandeira

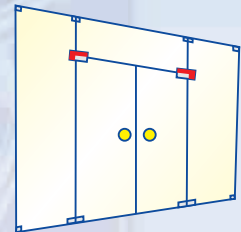

1214

Facão Direito para Lateral e Bandeira com Ponto de Giro Excêntrico

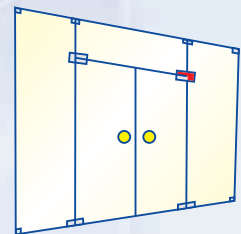

VISTA EXTERNA



1215

Facão Esquerdo para Lateral e Bandeira com Ponto de Giro Excêntrico

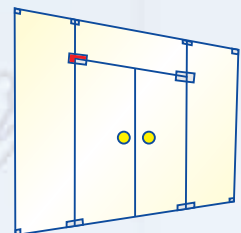

VISTA EXTERNA



1230

Suporte para Basculante

Disponível em Latão e Zamac

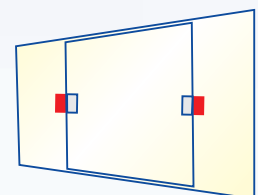



1231

Suporte com Ponto de Giro para Basculante e Pivotante

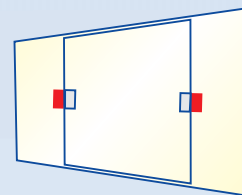

1301

Suporte de Canto para Bandeira com Batedeira Direita ou Esquerda

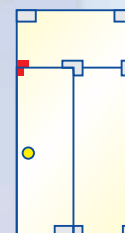

1302

Suporte de Canto
Disponível em Latão e Zamac

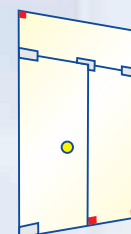

1304

Suporte sem Miolo para Dois Vidros

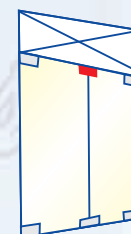

1305

Suporte para União de Dois Vidros sem Miolo

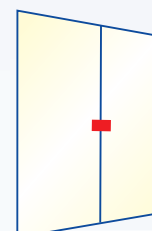



1306

Suporte com Miolo para União de Dois Vidros

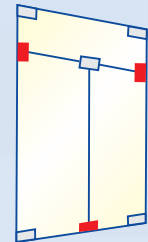

1307

Suporte sem Miolo para União de Três Vidros em "T"

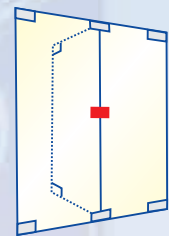

1308

Suporte com Miolo para União de Três Vidros em "T"

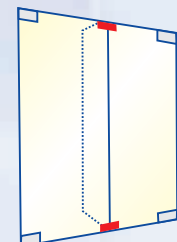

1309

Suporte sem Miolo para União de Três Vidros em "T"

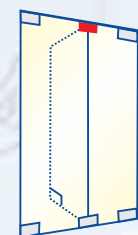

1310

Suporte para União de dois ou Três Vidros em "L"

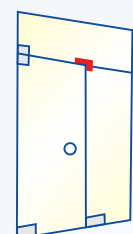



1315

Suporte para União de Dois ou Três Vidros em "L" com Batedeira

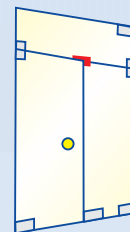

1316

Suporte para União de Quatro Vidros sem Miolo

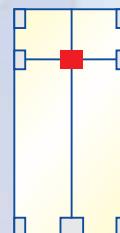

1319

Suporte de Canto para União de Quatro Vidros

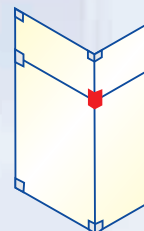

1320

Suporte sem Miolo e Cantoneira Central

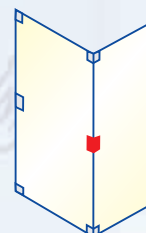

1321

Suporte com Miolo e Cantoneira Inferior/Superior

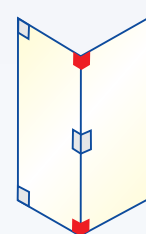

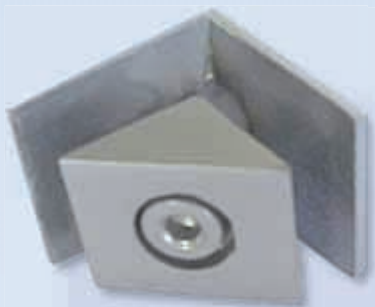

1322

Suporte de Cantoneira Central

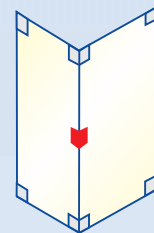

1323

Suporte sem Miolo para União de Quatro Vidros entre si

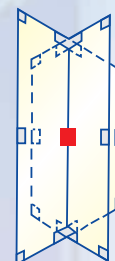

1325

Suporte sem Miolo para União de Quatro Vidros entre si

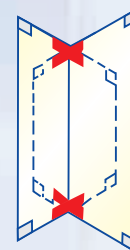

1326

Suporte para Fixação de Vidro Fixo

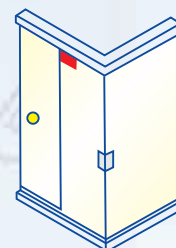

1329

Suporte de Centro

Disponível em Latão e Zamac

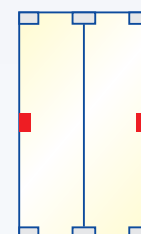



1335

Trinco sem Miolo

Disponível em Latão e Zamac

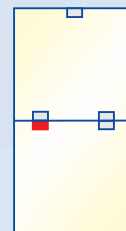

1335 A

Trinco com Miolo

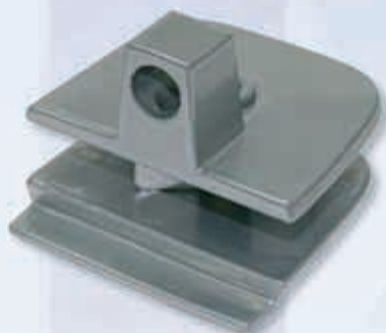
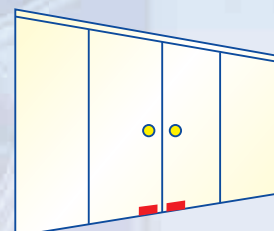

1335 C

Contra Trinco V/V

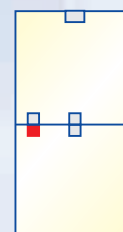

1336 D

Trinco de Canto com Miolo

Direito

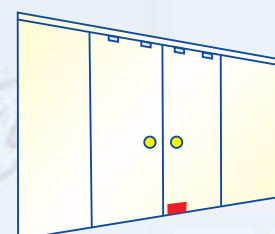

VISTA INTERNA



1336 E

Trinco de Canto com Miolo

Esquerdo

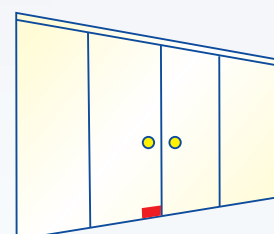

VISTA INTERNA



1401
Batedor Simples

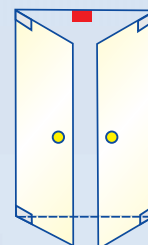

1402
Suporte com Batedor

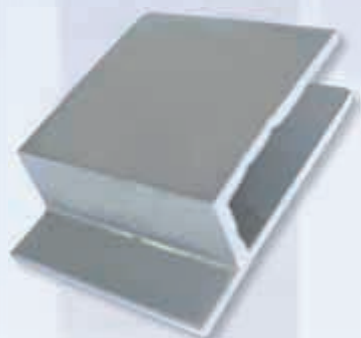
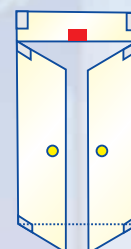

1402 S
Batedeira de Pressão

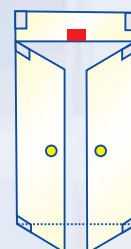

1404
Guia de Delrin para Porta de
Correr

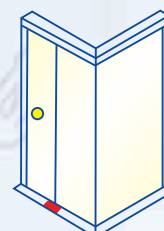

1405
Batedor Retangular de Borracha
para Box

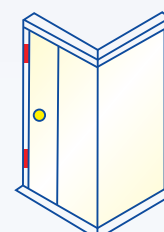



1406

Batedor de Borracha para Box

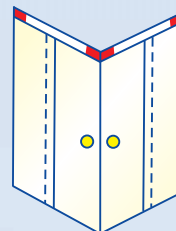

1502

Trinco Inferior com Miolo

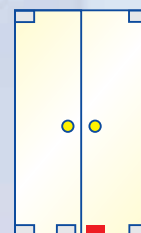

1504

Contra Fechadura com Recorte
para 1520

Disponível em Latão e Zamac

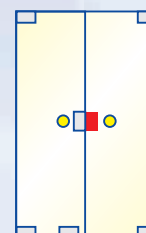

1504 A

Espelho para 1520

Disponível em Latão e Zamac



1504 S

Contra Fechadura de Pressão
para 1520 S

Vista Interna

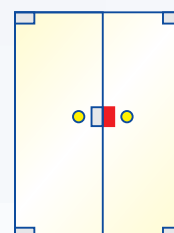



1505
Espelho Liso

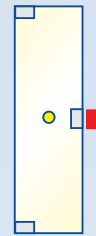

1510
Fechadura Bico-de-Papagaio

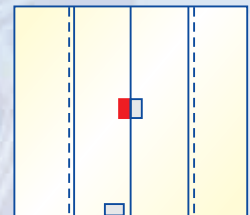

1510S
Fechadura de Pressão para
Porta de Correr

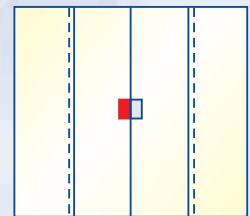

VISTA INTERNA



1510D
Fechadura Bico-de-Papagaio
para Janela
Direita

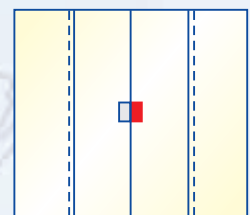

VISTA INTERNA



1510E
Fechadura Bico-de-Papagaio
para Janela
Esquerda

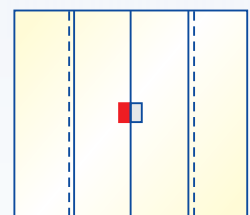

VISTA INTERNA



1511
Contra Fechadura para 1510

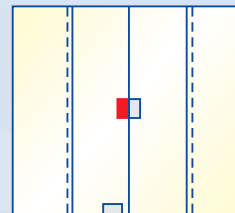

1511 D
Contra Fechadura para 1510 E

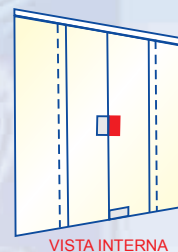

1511 E
Contra Fechadura para 1510 D

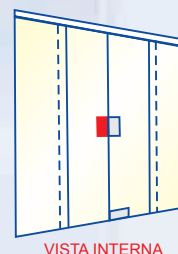

1511 A
Espelho para 1510 Alvenaria

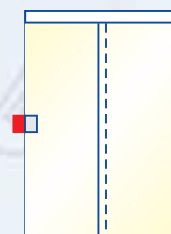

1511 S
Contra Fechadura de Pressão
para Porta de Correr

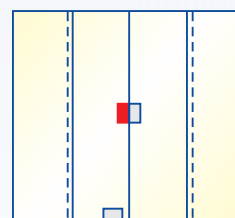



1513

Trinco para Basculante Direito
Vista Interna

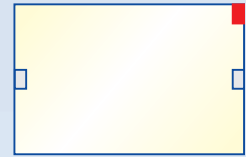

1519

Trinco Inferior sem Miolo

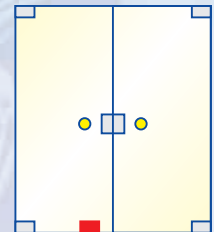

1520

Fechadura para Porta de Abrir

Disponível em Latão e Zamac
Disponível com Segredo Igual

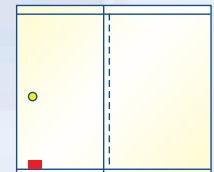

1520 S

Fechadura de Pressão Central

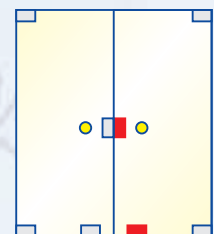

1520 TT

Fechadura Chave Tetra

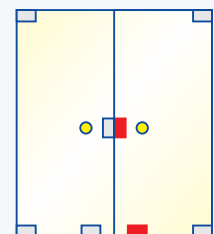



1520 PX

Fechadura para Porta de Abrir
com Puxador

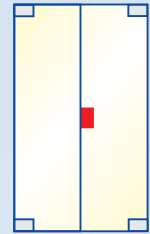

1522

Trinco para Basculante
Esquerdo

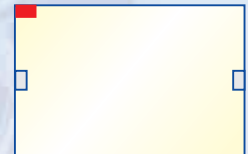

VISTA INTERNA



1523

Trinco Central para Basculante
Disponível em Latão e Zamac

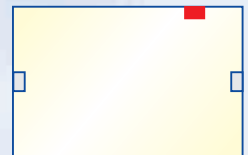

1524

Contra Trinco Central para
Basculante V/V

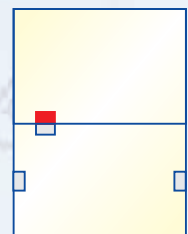

1525

Contra Trinco Direito para
Basculante

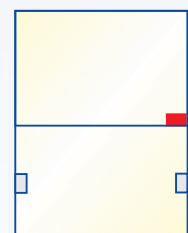

VISTA INTERNA



1526

Contra Trinco Esquerdo para Basculante

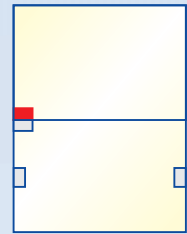

VISTA INTERNA



1528

Trinco para Box de um Lado

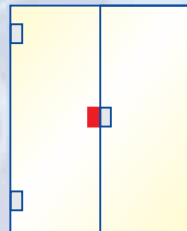

1529

Trinco para Box de Abrir dos 2 Lados

Disponível com um rolete apenas (Código: 1529/1)

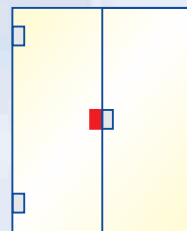

1530

Contra Trinco para Box de Abrir

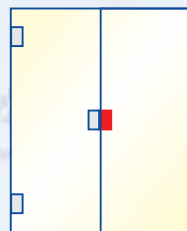

1530 A

Espelho para Trinco 1529 para Alvenaria

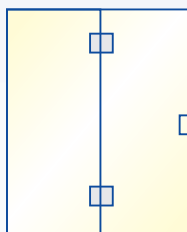



1531

Contra Fechadura com Aparador para 1520

Disponível em Latão e Zamac

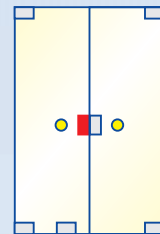

1531 PX

Contra Fechadura para Porta Abrir com Puxador

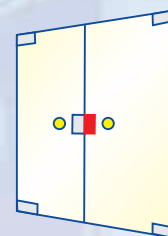

Escuro

Marfim

Mogno

1607

Puxador de Madeira

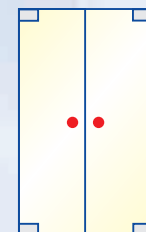

1629 A



1629 B

1629 A

Puxador de Latão com 22 mm de Diâmetro

1629 B

Puxador de Latão com 19 mm de Diâmetro

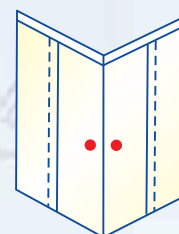

1629 J

Puxador de Latão com para Janela com 19 mm de Diâmetro

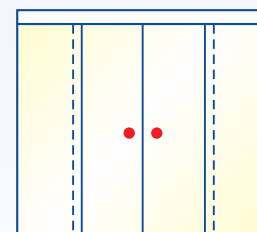



1636

Prolongador para Puxador de Vidro

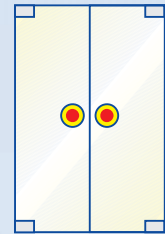

1800

Trinco de Pressão para Porta de Abrir

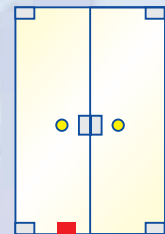

1800 A

Trinco de Pressão para Porta de Correr

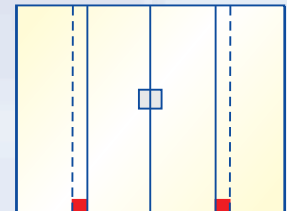

1800 AT

Trinco de Pressão para Porta de Correr

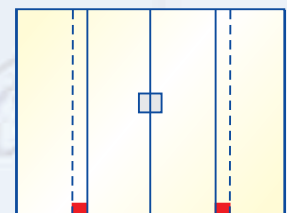

1800 F

Trinco com Parafuso para Porta de Correr

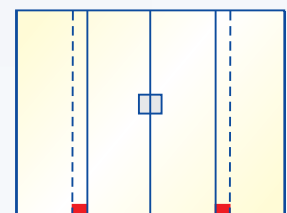

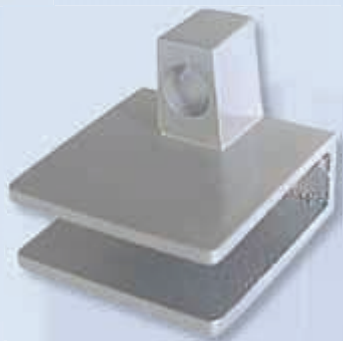

1800 C

Contra Trinco de Pressão V/V

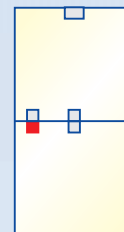

1801

Chapinha para Trinco Basculante

Disponível em Latão e Zamac

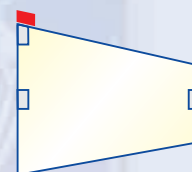

1801 C

Chapinha para Trinco de Piso

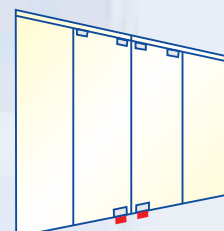

1801 D

Chapinha para Trinco de Porta de Correr com Furo Deslocado

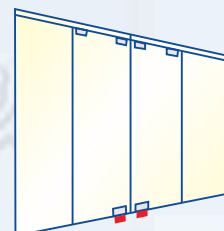

1871

Fixador de Porta para Rodapé

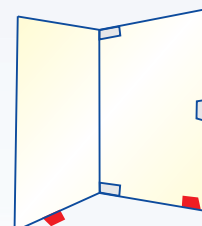

1872

Fixador de Porta para Piso



1037
Capuchinho Furo 8MM

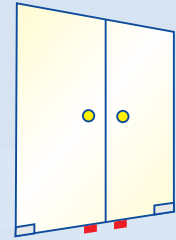

1038 BM
Capuchinho para Trinco 1335
Trilho Exposto Mini

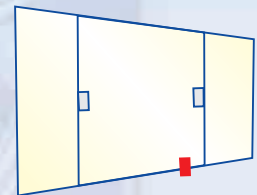

1101 M
Dobradiça para Rack
Superior e Inferior Mini



1123 M
Dobradiça para Vidro
Basculante Mini

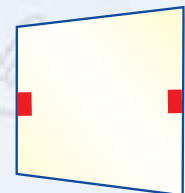

1136 M
Dobradiça Lateral Horizontal
Mini

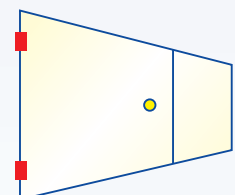



1137 M

Dobradiça Horizontal Dupla
Mini

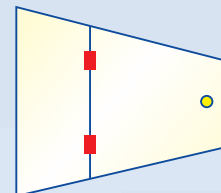

1201 M

Bucha para Pivô de Dobradiça
Mini

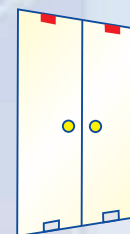

1201 MS

Bucha para Pivô de Dobradiça
1230 M

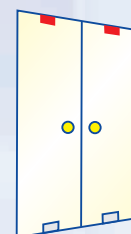

1230 M

Suporte para Basculante Mini

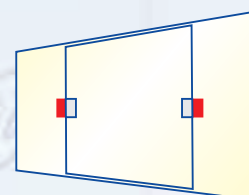

1329 M

Suporte de Centro Mini

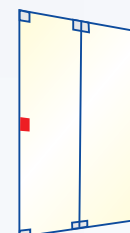



1335 M
Trinco sem Miolo Mini

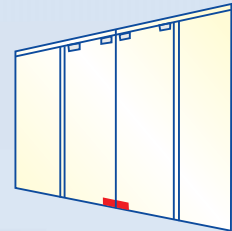

1335 CM
Contratrinco V/V Mini

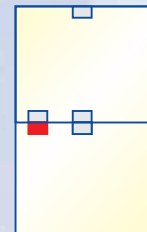

1520 R
Fechadura para Rack Pressão
Porta Simples Mini



1520 RD
Fechadura para Rack Pressão
Porta Dupla Mini

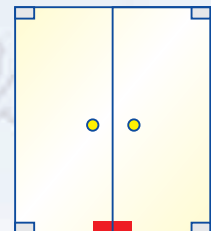

1523 M
Trinco Central para Basculante
Mini

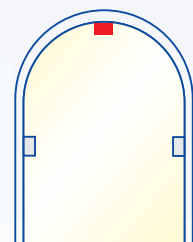



1524 M

Contratrinco Central para Basculante V/V Mini

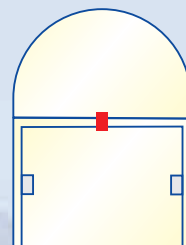

1629 JM

Puxador de Latão para Rack Mini

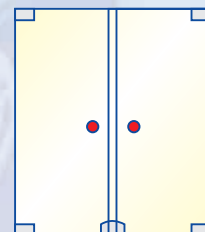

1629 M

Puxador de Latão Mini

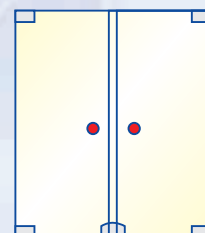

1801 M

Chapinha para Trinco Basculante Mini



1800 M

Trinco de Pressão Porta de Abrir Mini

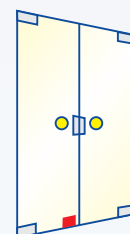



3210 MP

Fechadura de Centro Mini

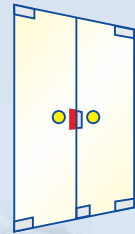

3211 MP

Contra Fechadura com
Aparador Mini (para 3210)

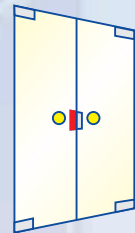

3230 A

Espelho para Fechadura
com Aparador para 3210,
3530 e 3532 Mini



3535 M

Trinco Mini para Janela
de Correr

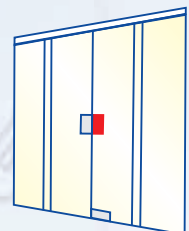

3434 M

Contra Trinco Mini V V para
Janela de Correr

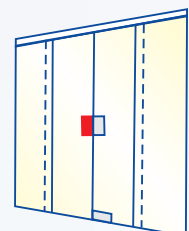



3530 M

Fechadura Mini para Porta de Correr

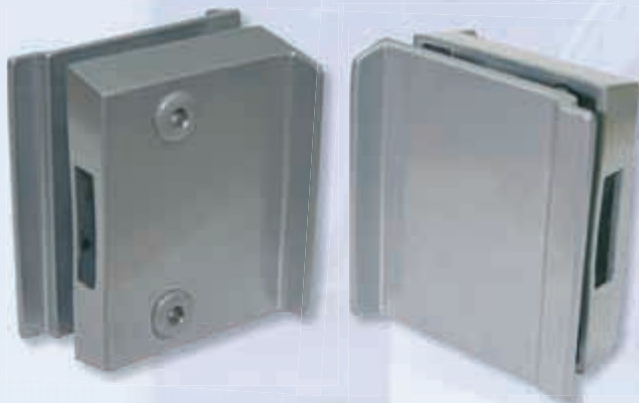
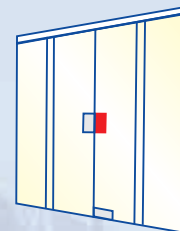

3534 M

Contra Fechadura Mini para Porta de Correr

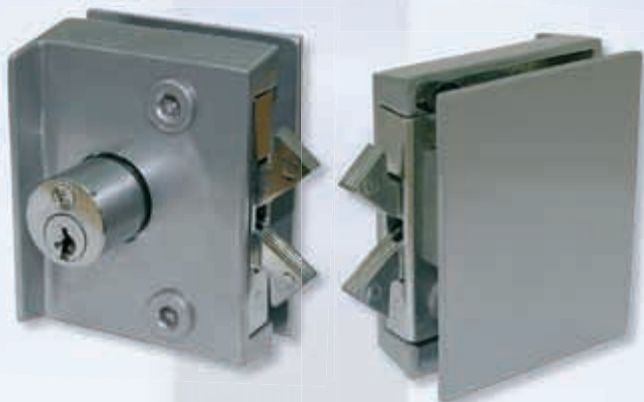
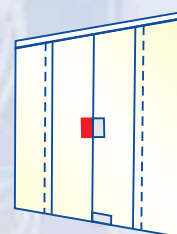

3532 JM

Fechadura Mini para Janela de Correr sem Cilindro Externo

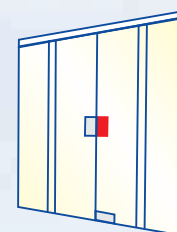

3536 JM

Contra Fechadura sem Puxador Externo Mini

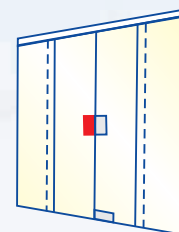

Recorte para as ferragens:
3210MP; 3211MP; 3535M; 3434M; 3530M;
3534M; 3532JM e 3536JM.

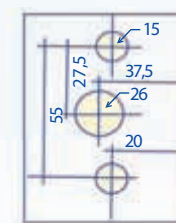



2009

Suporte Simples de Canto

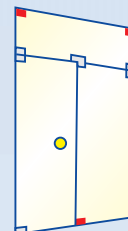

2010

Suporte Simples de Centro

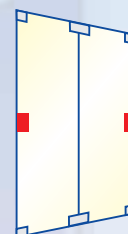

2105

Mancal Inferior para Dobradiça Porta



2110

Dobradiça Inferior



2122

Suporte de Batente para Dobradiça

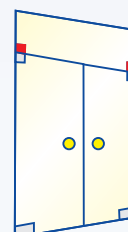



2132 / 2133

Suporte "L" para Dobradiça

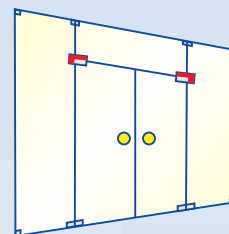

2140

Dobradiça Superior Simples



2210

Fechadura de Centro e Piso

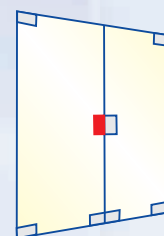

2210 GRD

Fechadura de Centro Grande
50x170

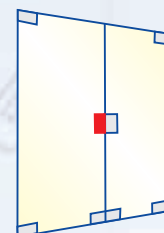

2211

Contra Fechadura com Aparador

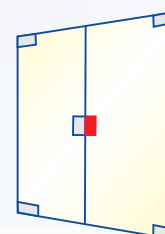



2211 GRD

Contra Fechadura Grande
50x170

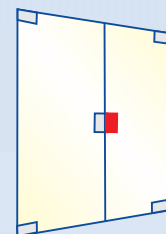

2212



2212 A

2212

Espelho para Fechadura com
Aparador

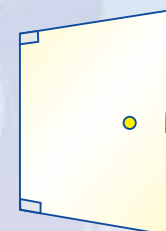

2212 A

Espelho para Fechadura sem
Aparador

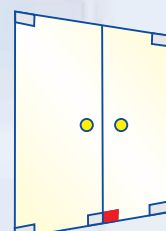

2240 / 2241

Trinco para Porta de Abrir

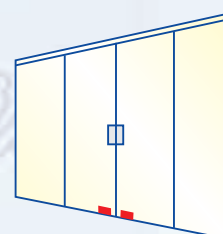

2242

Trinco de Pressão

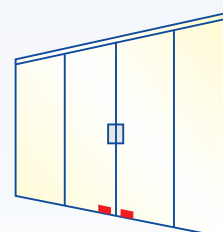

2245

Pino de Trava para Trinco de
Pressão



2247



2247 A

2247

Contra Trinco para 2245

2247 A

Contra Trinco para
2240 / 2241 / 2242

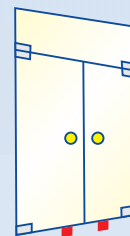

2401

Suporte Central para Janela
Basculante e Pivot



2402

Suporte Central para Janela
Basculante e Pivot

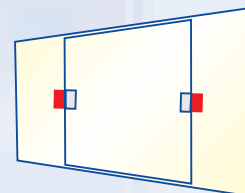

2405

Suporte Simples Central para
Janela Basculante

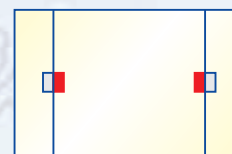

2406

Suporte Simples Central para
Janela Basculante

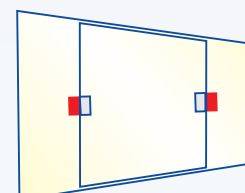



2410
Trinco com Corrente para
Janela Basculante (Completo)

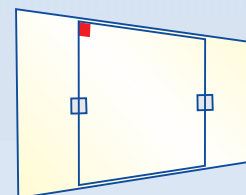

2411
Contra Trinco de Centro com
Aparador



2520
Carrinho para Porta de Correr



2701
Dobradiça Dupla para Box

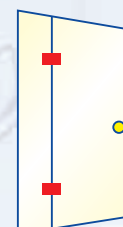

2702
Dobradiça Dupla de Canto

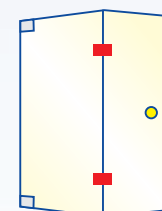



2703

Dobradiça de Box com Aba Larga



2704

Dobradiça de Box com Giro Interno



2705

Dobradiça de Box com Giro Externo

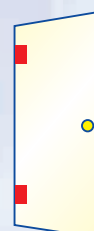

2708

Dobradiça automática para Box



2720

Trinco com Puxador de Metal para Box

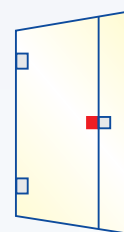



2721

Contra Trinco com Aparador Externo

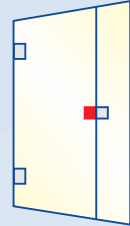

2723

Espelho para Trinco de Box



2730

Cantoneira Central de Box

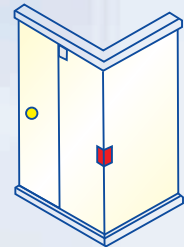

72 A - Linha 1000

Dobradiça Superior



72 B - Linha 1000

Dobradiça Inferior Linha 1000





3001
Suporte Duplo Vertical

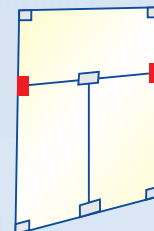

3002
Suporte Duplo Horizontal

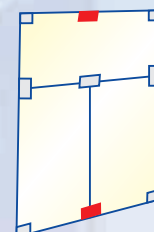

3003
Suporte Duplo Horizontal
com Capuchinho

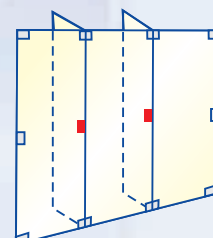

3004
Suporte Duplo Central

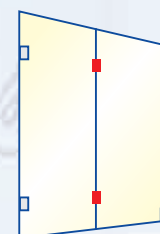

3006
Suporte Simples Vertical

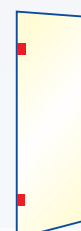



3007

Suporte Simples Vertical com Capuchinho

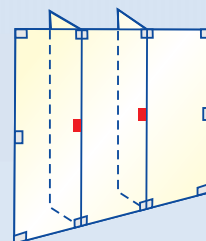

3009

Suporte Simples de Canto

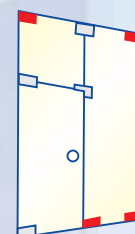

3010

Suporte Simples de Centro

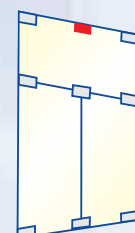

3013

Suporte de Centro com Capuchinho

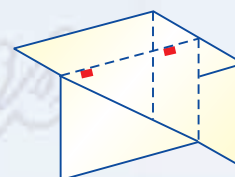

3014

Suporte Quádruplo

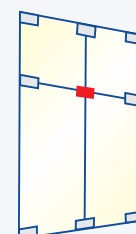



3016
Suporte Triplo

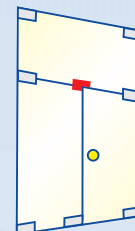

3017
Suporte Triplo com Aparador Reversível

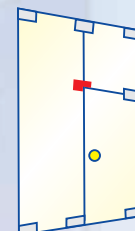

3022
Cantoneira com Núcleo

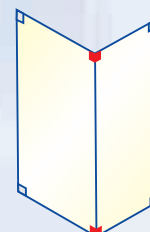

3023
Cantoneira sem Núcleo

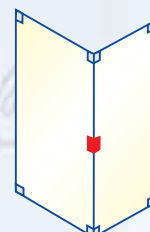

3025
Cantoneira Quádruplo

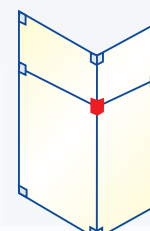



3105
Mancal Inferior para Porta

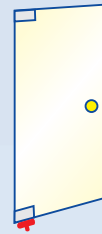

3106
Mancal Inferior para Pivotante



3107
Mancal Superior e Lateral Retangular



3110
Dobradiça inferior (para mola)

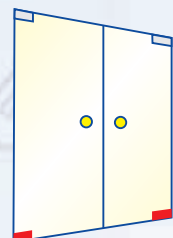

3122
Suporte de Batente

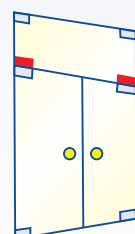



3123

Suporte para Dobradiça para Porta Pivotante

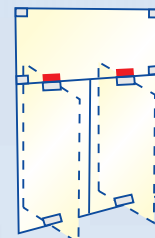

3132

Suporte "L" para Dobradiça

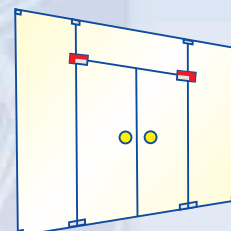

3140

Dobradiça Superior e Inferior
(para porta sem mola)

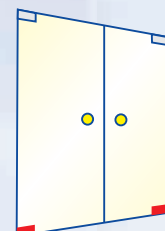

3141

Dobradiça para Porta Pivotante

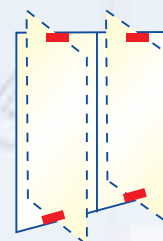

3143

Dobradiça Vidro/Vidro

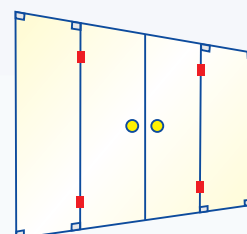



3144

Dobradiça de Batente

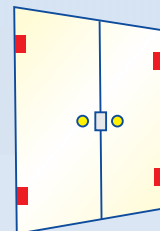

3145

Dobradiça para Porta Modelada Vidro/Vidro

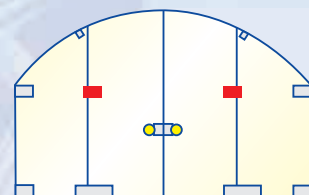

3146

Dobradiça para Porta Modelada com Aba Reta



3147

Dobradiça para Porta Modelada com Aba a 90°

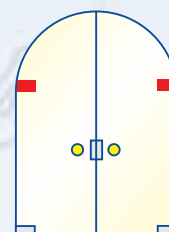

3210

Fechadura de Centro

Disponível em Latão e Zamac

Disponível com Segredo Igual

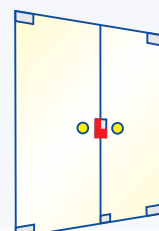



3211

Contra Fechadura com Aparador
para 3210

Disponível em Latão e Zamac

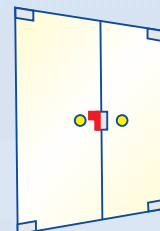

3212

Contra Fechadura sem Aparador
para 3210

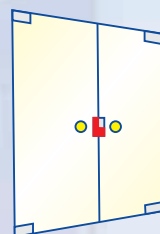

3215

Fechadura de Piso

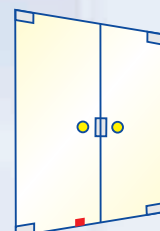

3230

Espelho para Fechadura com
Aparador (para 3210 e 3530
e 3532)

Disponível em Latão e Zamac



3232

Espelho para Fechadura sem
Aparador (para 3210 e 3530
e 3532)

Disponível em Latão e Zamac

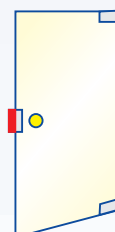



3240
Trinco de Piso

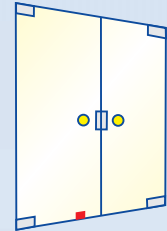

3241
Contra Pino de Vidro



3253
Suporte com Aparador

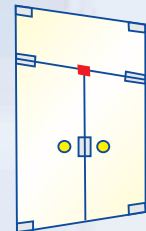

3254
Batedor para Porta de Abrir

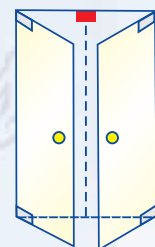

3401
Dobradiça para Janela
Basculante

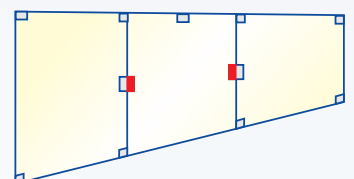



3402

Suporte para Dobradiça de Janela Basculante

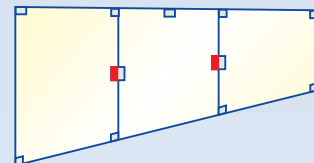

3407

Corrente para Trinco

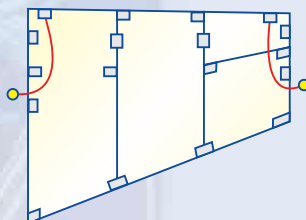

3407 A

Argola para Corrente

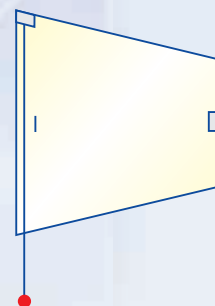

3408

Calota para Corrente de Alvenaria

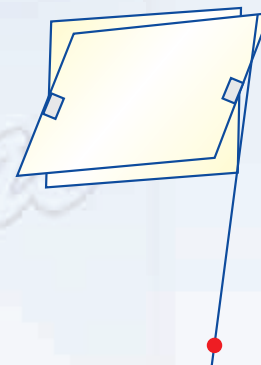

3410

Trinco Superior de Centro para Basculante (Completo)





3411

Contra Trinco de Centro para Basculante

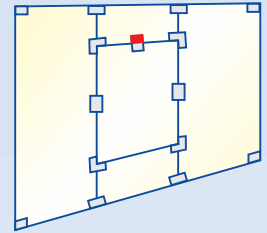

3414

Espelho para Trinco de Basculante

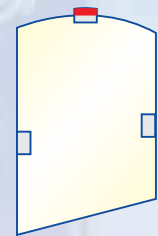

3438

Dobradiça para Janela Basculante (Pequena)

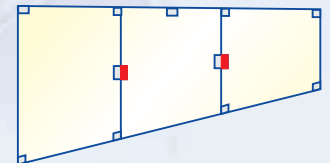

3439

Suporte para Dobradiça de Janela Basculante (Pequena)

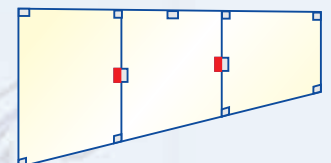

3530

Fechadura para Porta de Correr

Disponível em Latão e Zamac

Disponível com Segredo Igual

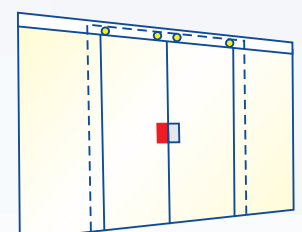



3532
Fechadura para Janela de
Correr sem Cilindro Externo
Disponível em Latão e Zamac

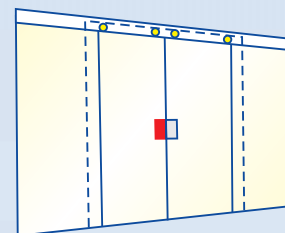

3534
Contra Fechadura para Porta
de Correr
Disponível em Latão e Zamac

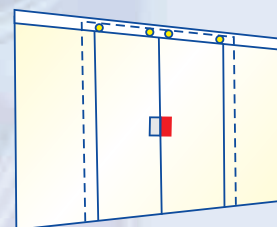

3536
Contra Fechadura para Janela
de Correr
Disponível em Latão e Zamac

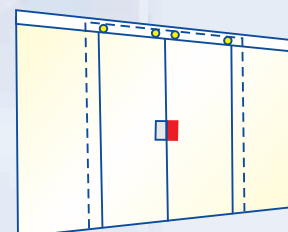

3539
Trinco para Porta de Correr

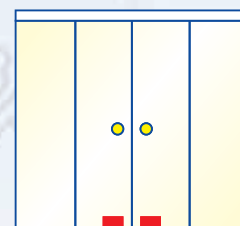

3540
Puxador para Porta de Correr

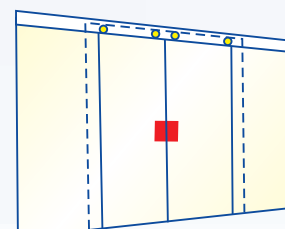



3701

Dobradiça Automática
Vidro/Vidro Esquerda

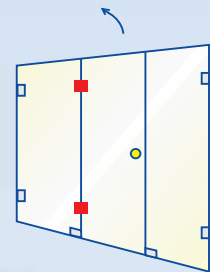

VISTA EXTERNA



3702

Dobradiça Automática
Vidro/Vidro Direita

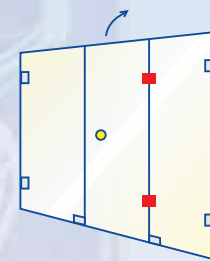

VISTA EXTERNA



3703

Dobradiça Automática
de Batente Esquerda

3704

Dobradiça Automática
de Batente Direita

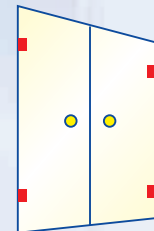

3715

Dobradiça Automática
de Batente Esquerda

3716

Dobradiça Automática
de Batente Direita

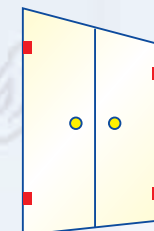

3730

Cantoneira de Centro
para Box

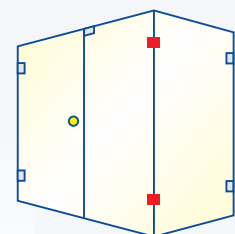



BR AL - Braço Porta Alumínio

BR MAD - Braço Porta Madeira



DM VA AL - Alumínio
Dobradiça Maxmar

DM VA G - Zamac
Dobradiça Maxmar



VISTA EXTERNA



VISTA INTERNA



VISTA INTERNA



VISTA EXTERNA

DM VV - Alumínio
Dobradiça Maxmar

DM VV - Latão
Dobradiça Maxmar



VISTA EXTERNA



VISTA INTERNA



VISTA EXTERNA



VISTA INTERNA

HTVA

Haste para Maxmar VA



HTVV

Haste para Maxmar VV

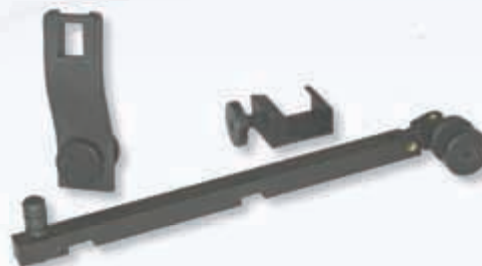



Pinça GRD

Pinça Grande 50x75



VISTA INTERNA

VISTA EXTERNA

Pinça MD

Pinça Média 25x50

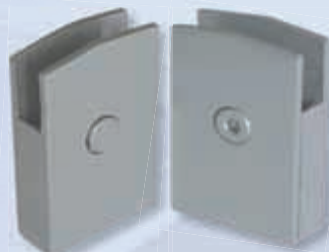

VISTA INTERNA

VISTA EXTERNA

Pinça PQN

Pinça Pequena 25x40



VISTA INTERNA

VISTA EXTERNA

PC

Porta Cadeado



PCS

Porta Cadeado



Suporte de Haste

VV Latão - Dois Furos



VISTA INTERNA

VISTA EXTERNA

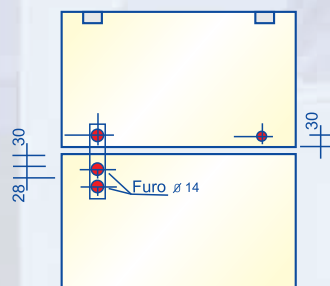

Puxador de Vidro



- Incolor
- Verde
- Bronze
- Fumê

Suporte Tucano Médio

Suporte Tucano Grande

Disponível nas cores:

- Cromado
- Preto
- Marom
- Branco
- Pintura Fosca





Dobradiças Reforçadas



1101 R

Dobradiça Superior Reforçada
com 3 Furos

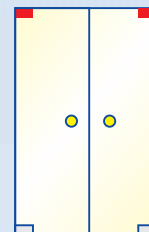

1103 R

Dobradiça Inferior Reforçada
com 3 Furos

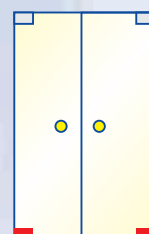

1101 PG

Dobradiça Superior Reforçada
com 4 Furos

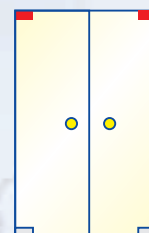

1103 PG

Dobradiça Inferior Reforçada
com 5 Furos

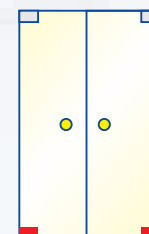



1129 D à 90°
Dobradiça Dupla Automática
Vidro Vidro
Direita

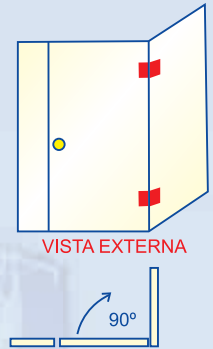

1129 E à 90°
Dobradiça Dupla Automática
Vidro Vidro
Esquerda

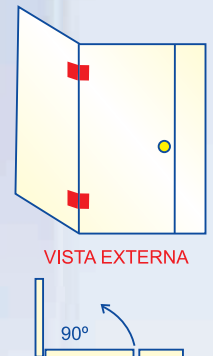

1129 D à 135°
Dobradiça Dupla Automática
Vidro Vidro
Direita

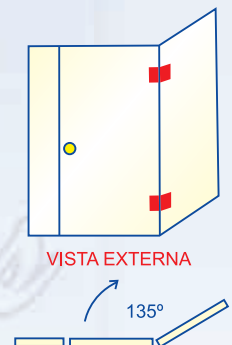

1129 E à 135°
Dobradiça Dupla Automática
Vidro Vidro
Esquerda

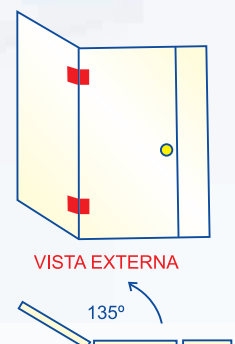



Linha Ferragens Especiais



1129D - Pedra Granito

Dobradiça Automática
Vidro Granito 20mm/30mm

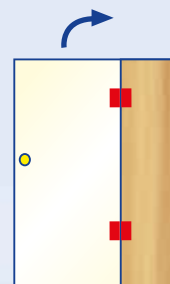

VISTA EXTERNA



1129E - Pedra Granito

Dobradiça Automática
Vidro Granito 20mm/30mm

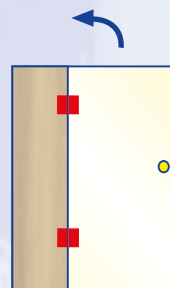

VISTA EXTERNA



1129DC - Pedra Granito

Dobradiça Automática
Vidro Granito 20mm/30mm

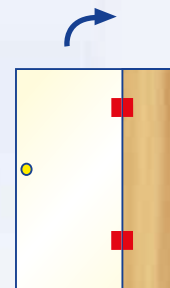

VISTA EXTERNA



1129EC - Pedra Granito

Dobradiça Automática
Vidro Granito 20mm/30mm

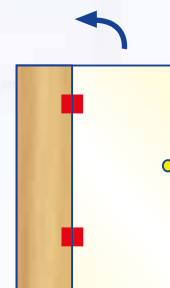

VISTA EXTERNA



1114A

Dobradiça Automática para Box com aba na tampa, abre para fora

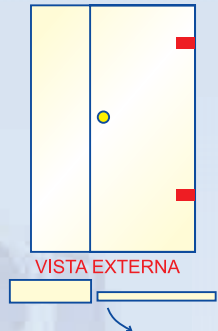

1203 - Tubo 50x50

Suporte com Bandeira Fixo em Tubo Quadrado

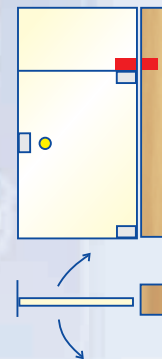

1203 - Tubo Ø50 ou Ø75

Suporte com Bandeira Fixo em Tubo Redondo

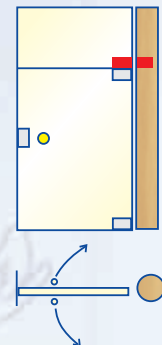

1209 D à 90°

Facão Direito p/ Lateral e Bandeira

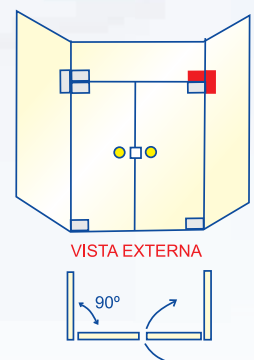



Linha Ferragens Especiais



1209 E à 90°
Facão Esquerdo p/ Lateral
e Bandeira

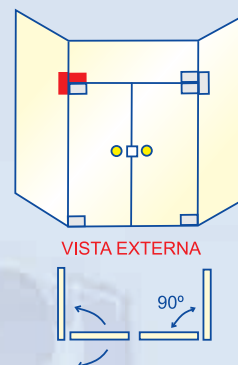

1209 D à 135°
Facão Direito p/ Lateral
e Bandeira

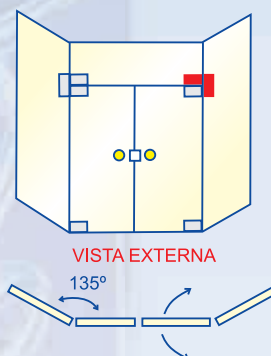

1209 E à 135°
Facão Esquerdo p/ Lateral
e Bandeira

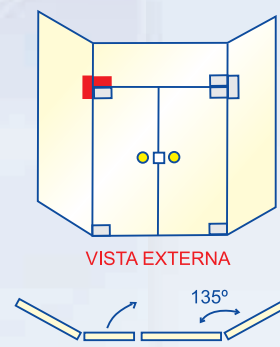

1310 D à 90°
Suporte Direito para União
de Dois ou mais Vidros em "L"

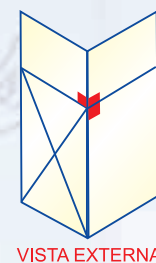

1310 E à 90°
Suporte Esquerdo para União
de Dois ou mais Vidros em "L"

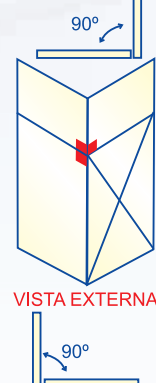



1310 D à 135°
Suporte Direito para União
de Dois ou mais Vidros em "L"

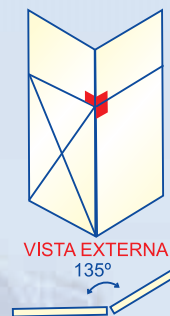

VISTA EXTERNA
135°



1310 E à 135°
Suporte Esquerdo para União
de Dois ou mais Vidros em "L"

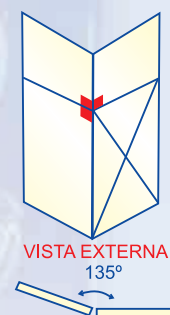

VISTA EXTERNA
135°



1319 à 135°
Suporte para União de Quatro
Vidros

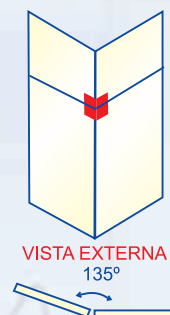

VISTA EXTERNA
135°



1320 à 135°
Suporte sem Miolo para União
de Dois Vidros

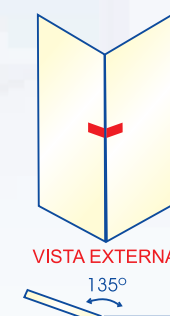

VISTA EXTERNA
135°



Linha Ferragens Especiais



1321 à 135°
Suporte com Miolo para União
de Dois Vidros

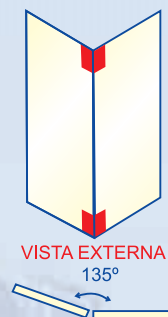

VISTA EXTERNA
135°

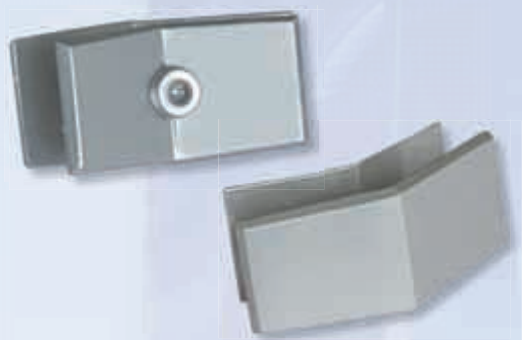

1322 à 135°
Suporte para União de Dois
Vidros

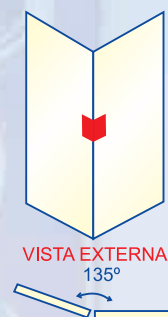

VISTA EXTERNA
135°



1520 Pino Longo
Fechadura Central com Pino
20mm

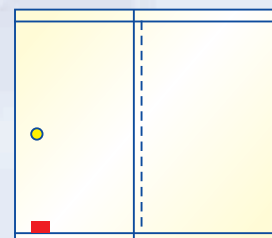

3534 à 90°
Contra Fechadura para porta
Obs.: Recorte da 3530 para
usar com a 3534 à 90°

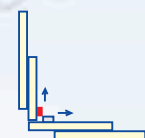
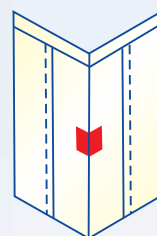
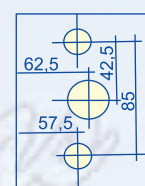

3534 à 135°
Contra Fechadura para porta
Obs.: Recorte da 3530 para
usar com a 3534 à 135°

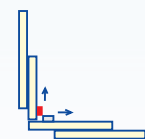
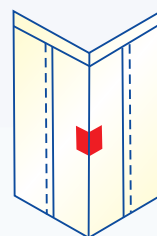
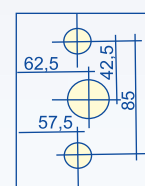

Linha Ferragens Especiais



Puxador Unha

Puxador para Box de Vidro 8mm



SV1T

Suporte para União de Um Vidro com Apoio em Tubo



SV2T

Suporte para União de Dois Vidros com Apoio em Tubo



SV2

Suporte para União de Dois Vidros



SV3

Suporte para União de Três Vidros



1 A MA

Conj. mão de amigo para porta de correr



1 A MA M

Conj. mão de amigo para porta de correr mini





Linha Prolongador

Prolongador PL 1



Prolongador PL 2



Prolongador PL 3



Prolongador PL 4



Prolongador PL 5



PL 6 Canopla 1



Linha Prolongador



PL 7 - Roldana para Cola UV



PL 8 - Canopla 2



PL 9 - Roldana com Tubo



Detalhe da Furação do Vidro

Tubo Ø 1" (25mm)
Furação de 14mm



Tubo 1 ½" (38mm)
à 4" (100mm)
Furação de 18mm

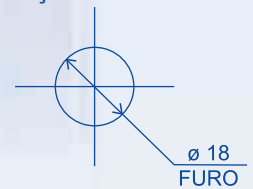

PL R - Prolongador Reforçado

(Diâmetro e altura sob encomenda, de acordo com projeto)

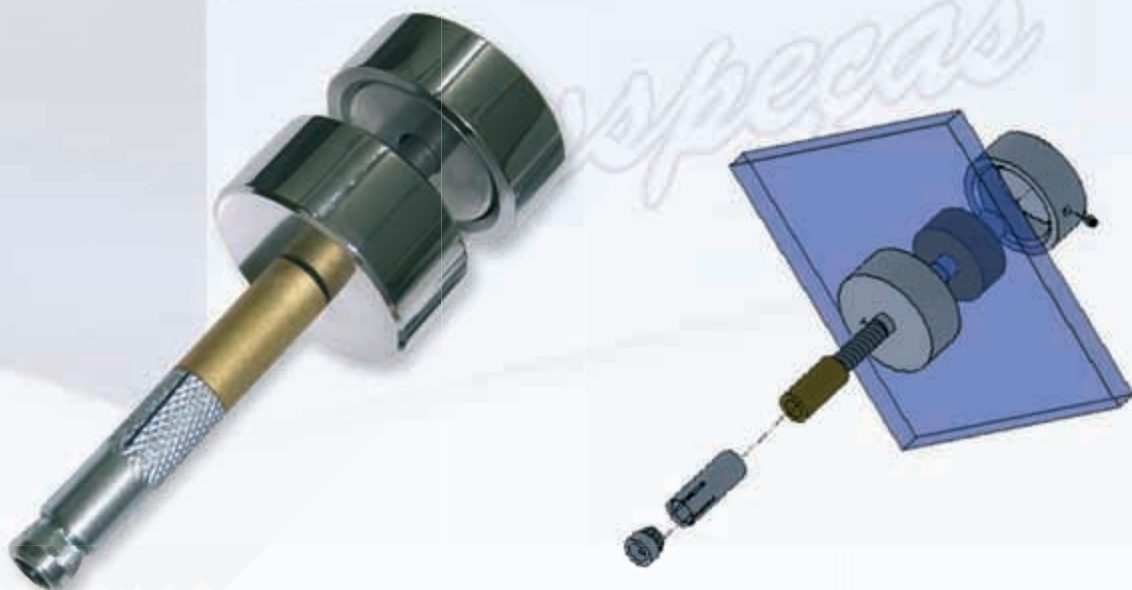



Linha Puxador Tubular

Puxador Tubular 376

300 mm entre furo

Disponível em Latão e Alumínio



Puxador Tubular 276

200 mm entre furo

Disponível em Latão e Alumínio



Puxador Tubular H

Tubo 25 ou 38

Disponível em Latão e Alumínio

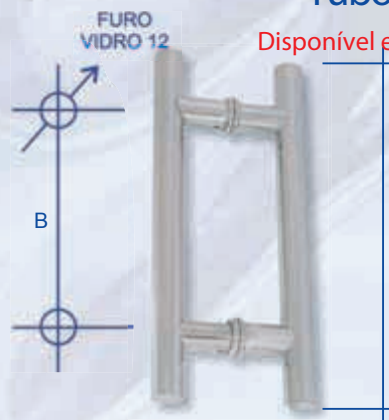

A	B
COMPRIMENTO TOTAL	DISTÂNCIA ENTRE O FURO
300	200
500	300
600	400
800	600
1000	800

Puxador Tubular 25 MW

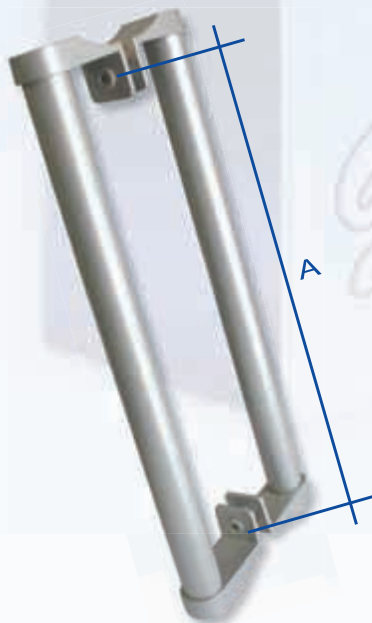

Cores:

Cromado

Preto

Bronze

Branco

Pintura Fosca



DIMENSÕES	
A	200 mm
	300 mm
	400 mm
	500 mm
	600 mm

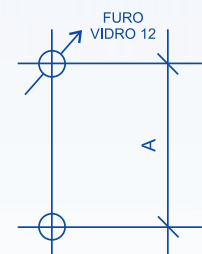

Linha Fechaduras de Maçaneta



1520 ML

Fechadura com maçaneta simples para porta de abrir

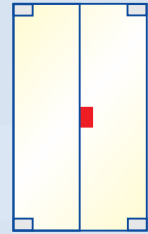

VISTA EXTERNA



1520 MF

Fechadura com maçaneta "Golf" para porta de abrir

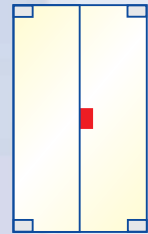

VISTA EXTERNA



1507

Contra fechadura para 1520 MAS e 1520 MAG

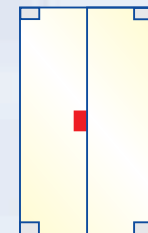

VISTA EXTERNA



1506 AD

Contra fechadura alvenaria direita para 1520 ML e 1520 MF

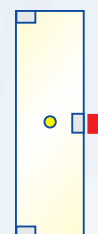

VISTA EXTERNA



1506 AE

Contra fechadura alvenaria esquerda para 1520 ML e 1520 MF



VISTA EXTERNA



B 201

Bucha para 1201/1203/1209



N 114

Nylon para 114/129 - Base Redonda



114 QUAD

Nylon para 114/129 - Base Quadrada



N 115 - Nylon para 115/129



Capa para Parafuso

PN - Pino Dob. 114 e 129

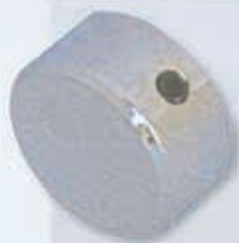

Chave Alen Sextavada

1 FA - Fecho Avião





Suporte Fecho Magnético

Fecho Magnético

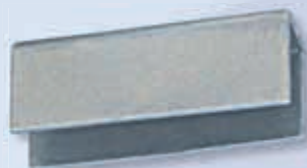

8 mm



6 mm

FC - Folha Cortiça 600x450

GB - Guia para Box



M 2000 - Miolo para Dob. linha 2000

1 P 126 - Parafuso 126

M 3000 - Miolo para Dob. linha 3000

M 103 - Miolo para 103



1 PA - Parafuso Alen

1 PA 3000 - Parafuso L 3000





TR 335 Longo

Pino 335 Longo



P 101

Pino Dob. 101 e 123



8 mm



10 mm

TR 335 - Pino e Trava 335



TB - Tampa Tubo



19

25

38

50

Curiosidades



Zamac é uma liga à base de zinco, composto por quatro elementos básicos para sua formação: Alumínio (Al), Cobre (Cu), Magnésio (Mg) e Zinco (Zn). É uma liga muito usada em fundição sob pressão para a produção de pequenas peças com estreito controle dimensional. Possui boa resistência à corrosão, tração, choques e desgastes, e tem uma tonalidade cinza.

Dentre todas as ligas de metais não ferrosos, o Zamac é uma das que possui maior utilização, devido às suas propriedades físicas, mecânicas e à fácil capacidade de revestimento por eletrodeposição (Banho de cromo, níquel, cobre). O seu baixo ponto de fusão permite uma maior durabilidade do molde, permitindo uma maior produção de peças em séries fundidas.

Exemplos comuns de aplicação são as maçanetas metálicas usadas para abrir os vidros das portas dos automóveis, fechaduras residenciais e industriais, carcaças de liquidificadores, batedeiras e ventiladores, dobradiças de refrigeradores, componentes de relógios, grades de rádio e televisores e componentes de ferragens para construção civil e marcenaria.

Para a composição das ferragens da Glasspeças é utilizado o Zamac ZC5T, com 94,306% de Zinco em sua composição.

Aplicações

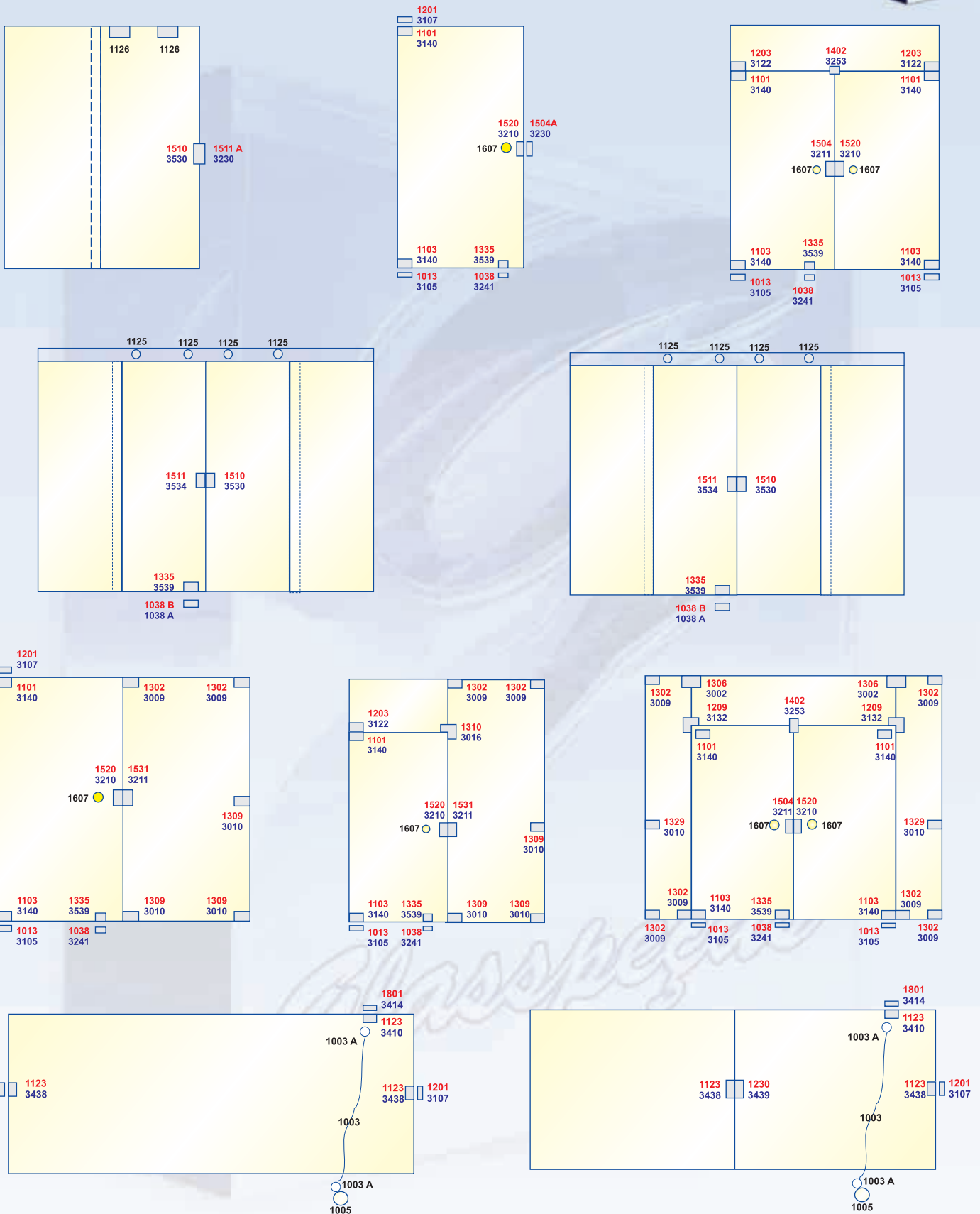

LEGENDA

■ Santa Marina

■ Linha 3000

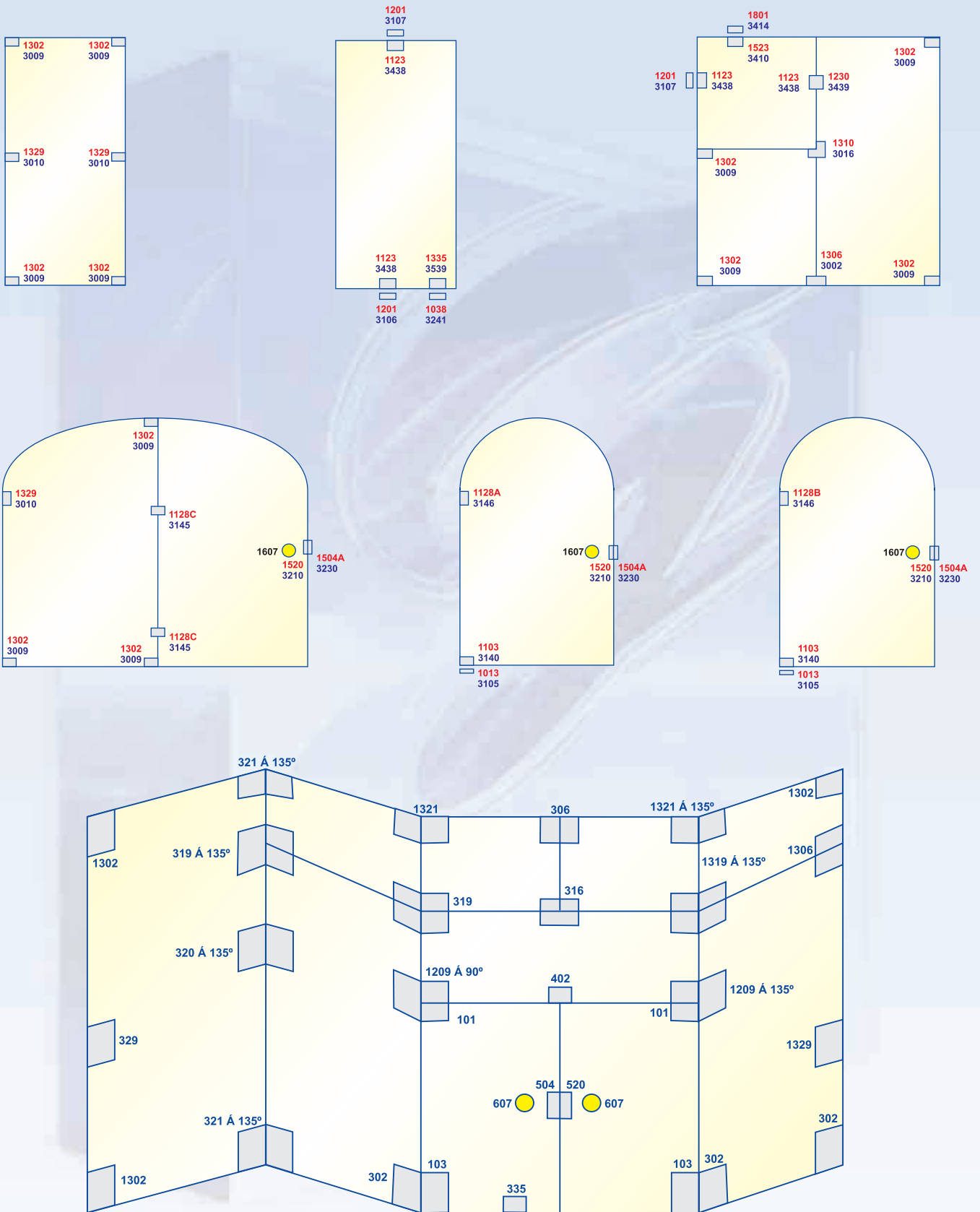

LEGENDA

■ Santa Marina

■ Linha 3000



Acabamento



Branco



Cromado



Preto



Cromo Escovado



Bege



Pintura Fosca



Marrom



Dourado



Vermelho



Champagne



Azul



Bronze



Verde

É proibida a reprodução total ou parcial deste catálogo sem autorização da Glasspeças Ind. e Com. Ltda. Todas as fotos e desenhos são meramente ilustrativos, podendo ser alterados sem prévio aviso.



EDIÇÃO 2010

Fones: (11) 5670 - 9900

Rua Alto do Bonfim, 328 • V. Santa Catarina • 04382-070 • São Paulo • SP
vendas@glasspecas.com.br • glasspecas@glasspecas.com.br